

MOBILE CABINET 3D

The Machlab design team has recreated the mobile cabinet to meet international ISO standards of quality and durability. The cabinet features solid construction with reinforced shelves, doors and carcass. All fittings are made of stainless steel and aluminium alloy to withstand harsh working environments. Functional yet aesthetically pleasing – it exuberates a smart, clean and modern look.

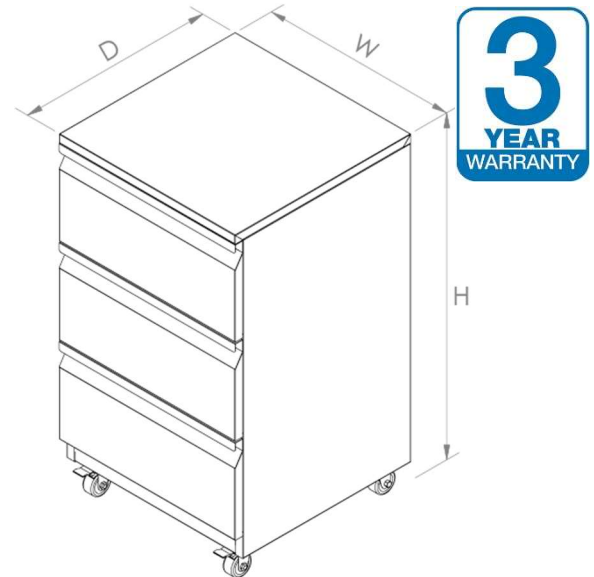

FEATURES

- Durable **lab-grade construction**
- **100 microns** powder coating finish
- **Corrosion resistance** certified
- **Dust-free** safety flush handles
- Optional **PP spill tray** available
- Optional security lockset available
- Best industry **warranty (3 years)**

FINISH OPTIONS

Powder coated steel components or stainless steel finish. Custom colour matching available upon request.



SPECIFICATIONS

- **Certified quality** (ISO2178, ISO2813, ISO2409, ASTM 117, ASTM D3363)
- Manufactured of **heavy-duty steel** (22-gauge, electro-galvanised)
- Stainless steel ball bearing full extension telescopic **drawer slides, 35kg weight capacity**
- Stainless steel/Aluminium alloy fittings (**Antirust**)
- **40mm PU castors** with brakes, **140kg load capacity**

MODELS

	W	D	H
MC-3D-454080	450	400	800
MC-3D-604080	600	400	800
MC-3D-454580	450	450	800
MC-3D-604580	600	450	800