

INSPECTION TABLE 01

Quality inspection is a straining yet critical process in the production of consumer goods such as textiles and rubber gloves. MACHLAB™ Inspection Tables are ergonomically designed to minimize the physical strain on your posture and eyes, especially over long periods of use.

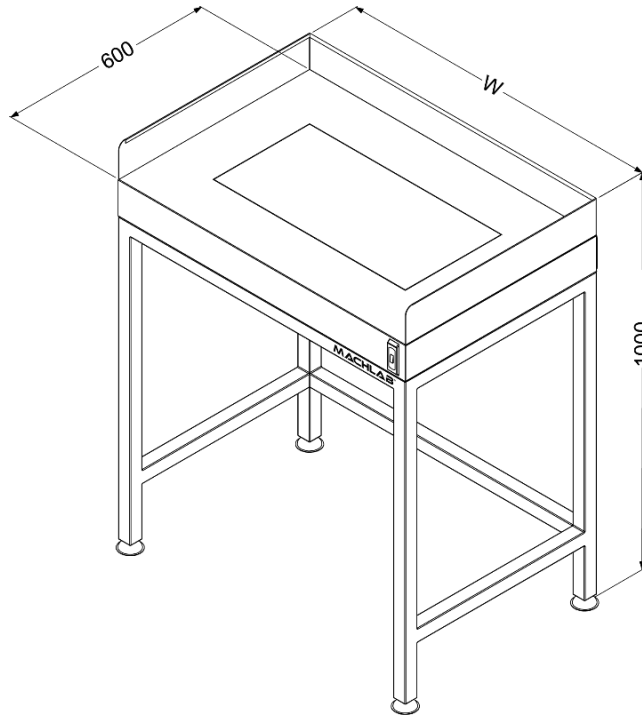

FEATURES

- **Anti-glare and anti-reflection** viewing screen
- **5mm** translucent white acrylic panel
- **Energy saving** LED lights with uniform illumination
- **Fully welded joints**, industrial grade construction
- **Heat exhaust fan** available on request

SPECIFICATIONS

- **Certified quality** (ISO2178, ISO2813, ISO2409, ASTM B117, ASTM D3363)
- **Oven baked epoxy powder** coated steel components
- **Stainless steel** heavy-duty 50mm height adjustable feet
- **UK standard** 240V, 13A, type G plug

FINISH OPTIONS

Powder coated steel components or stainless steel finish.
Custom colour matching available upon request.

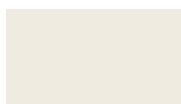

919

23



805

SS304 / SS316

MODELS

	W	D	H
IT-01A	900	600	1000
IT-01B	1200	600	1000