

OMNIBENCH™ HEAVY-DUTY WORKBENCH 3D

OMNIBENCH™ heavy duty workbenches share common design qualities that have earned MACHLAB® a trusted reputation in the industry. Typical features include a wide variety of drawer and door combinations to meet every job and storage requirement; fully welded base frames for strong loading capacity; extensive selection of task-oriented materials for work surfaces.



FEATURES

- **1000 kg** UDL Load capacity
- **Fully welded joints**, industrial grade construction
- **Corrosion resistance*** certified
- **Heavy-duty** adjustable stainless steel stabilisers
- **100 microns** powder coating finish

SPECIFICATIONS

- **Certified quality** (ISO2178, ISO2813, ISO2409, ASTM B117, ASTM D3363)
- **SHS 65x65x2.0mm steel base frame**
- **RHS 38x65x2.0mm steel crossbars**
- **Oven baked epoxy powder** coated steel components

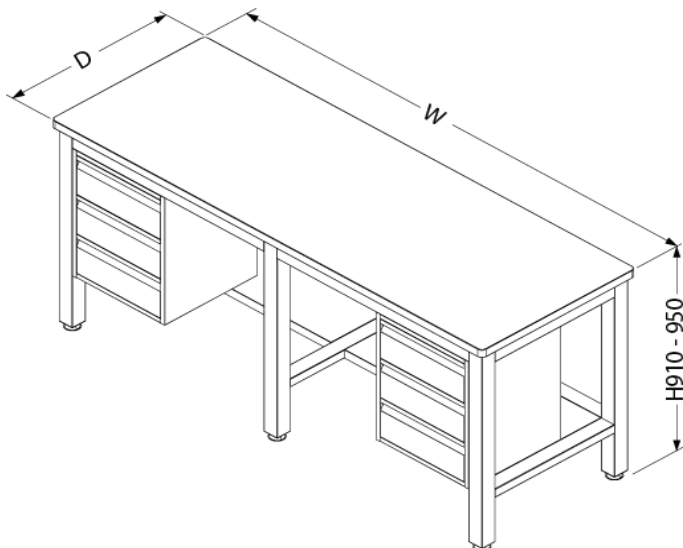

MODELS	W	D	H**
OB-2175	2100	750	910-950
OB-2475	2400	750	910-950
OB-2190	2100	900	910-950
OB-2490	2400	900	910-950
OB-21105	2100	1050	910-950
OB-24105	2400	1050	910-950

FINISH OPTIONS

Powder coated steel components or stainless steel finish.
Custom colour matching available upon request.

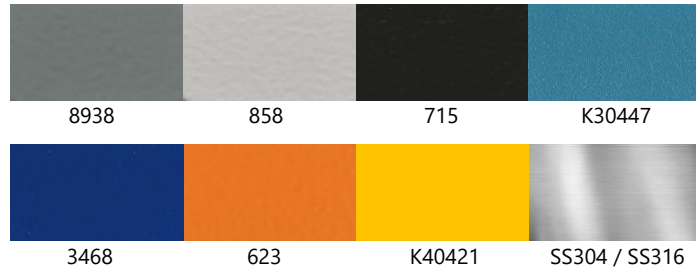

WORK SURFACE MATERIAL OPTIONS

Work surface material available upon request.

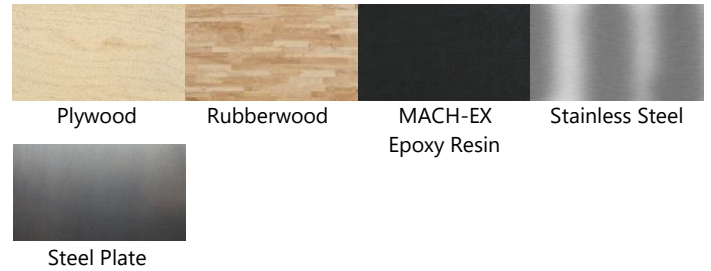

*Except wood-based worktops.

**Total height of workbench varies from 910mm to 950mm, depending on the selected worktop thickness.